



## Infrared thermometer

JIT

JIT 100



PROFESSIONAL MEASURING

English version

### Operating Instructions Infrared Thermometer

Version 1.0  
2024-03  
en  
JIT100-BA-d-2410

de

Weitere Sprachversionen  
finden Sie online unter

[www.kern-sohn.com/manuals](http://www.kern-sohn.com/manuals)

fr

Vous trouverez d'autres  
versions de langue online  
sous

[www.kern-sohn.com/manuals](http://www.kern-sohn.com/manuals)

bg

Други езикови версии ще  
намерите в сайта

[www.kern-sohn.com/manuals](http://www.kern-sohn.com/manuals)

el

Άλλες γλωσσικές αποδόσεις  
θα βρείτε στην ιστοσελίδα

[www.kern-sohn.com/manuals](http://www.kern-sohn.com/manuals)

hr

Druge jezične verzije su  
dostupne na stranici :

[www.kern-sohn.com/manuals](http://www.kern-sohn.com/manuals)

lv

Citas valodu versijas  
atradīsiet vietnē

[www.kern-sohn.com/manuals](http://www.kern-sohn.com/manuals)

pt

Encontram-se online mais  
versões de línguas em

[www.kern-sohn.com/manuals](http://www.kern-sohn.com/manuals)

sl

Druge jezikovne različice na  
voljo na spletni strani

[www.kern-sohn.com/manuals](http://www.kern-sohn.com/manuals)

en

Further language versions  
you will find online under

[www.kern-sohn.com/manuals](http://www.kern-sohn.com/manuals)

it

Trovate altre versioni di  
lingue online in

[www.kern-sohn.com/manuals](http://www.kern-sohn.com/manuals)

cs

Jiné jazykové verze najdete  
na stránkách

[www.kern-sohn.com/manuals](http://www.kern-sohn.com/manuals)

et

Muud keeleversioonid leiata  
Te leheküljel

[www.kern-sohn.com/manuals](http://www.kern-sohn.com/manuals)

hu

A további nyelvi változatok a  
következő oldalon  
találhatók:

[www.kern-sohn.com/manuals](http://www.kern-sohn.com/manuals)

nl

Bijkomende taalversies vindt  
u online op

[www.kern-sohn.com/manuals](http://www.kern-sohn.com/manuals)

ro

Alte versiuni lingvistice veți  
găsi pe site-ul

[www.kern-sohn.com/manuals](http://www.kern-sohn.com/manuals)

sv

Övriga språkversioner finns  
här

[www.kern-sohn.com/manuals](http://www.kern-sohn.com/manuals)

es

Más versiones de idiomas  
se encuentran online bajo

[www.kern-sohn.com/manuals](http://www.kern-sohn.com/manuals)

pl

Inne wersje językowe znajdują  
Państwo na stronie

[www.kern-sohn.com/manuals](http://www.kern-sohn.com/manuals)

da

Flere sprogudgaver findes  
på websiden

[www.kern-sohn.com/manuals](http://www.kern-sohn.com/manuals)

fi

Muut kieliversiot löytyvät  
osoitteesta

[www.kern-sohn.com/manuals](http://www.kern-sohn.com/manuals)

lt

Kitas kalbines versijas rasite  
svetainėje

[www.kern-sohn.com/manuals](http://www.kern-sohn.com/manuals)

no

Andre språkversjoner finnes  
det på

[www.kern-sohn.com/manuals](http://www.kern-sohn.com/manuals)

sk

Iné jazykové verzie nájdete  
na stránke

[www.kern-sohn.com/manuals](http://www.kern-sohn.com/manuals)



**SAUTER GmbH**

Ziegelei 1  
72336 Balingen-Frommern  
Germany



+0049-[0]7433-9933-0



+0049-[0]7433-9933-149



Info.sauter@kern-sohn.com



[www.sauter.eu](http://www.sauter.eu)



**SAUTER**

**SAUTER JIT**

**Infrared thermometer**

**Operating Instructions Infrared Thermometer**

Version 1.0 2024-03 English version

Table of contents:

**1 Technical data..... 3**

**2 Declaration of Conformity ..... 5**

**3 Overview of the device..... 6**

3.1 Scope of delivery ..... 6

3.2 Components ..... 6

**4 Basic information (general)..... 7**

4.1 General information on warning notices ..... 7

4.2 Intended use ..... 8

4.3 Improper use ..... 8

4.4 Warranty ..... 9

**5 Basic warnings and safety instructions..... 10**

5.1 Observe the notes in the operating instructions ..... 10

5.2 Staff training ..... 10

5.3 Security ..... 10

**6 Transport and storage ..... 13**

6.1 Hint ..... 13

6.2 Transport ..... 13

6.3 Storage ..... 13

6.4 Packaging/return transport ..... 13

**7 Unpacking and commissioning ..... 14**

7.1 Unpacking ..... 14

7.2 Initial commissioning ..... 14

**8 LCD display ..... 15**

**9 Basic operation..... 16**

9.1 Display the last measured value ..... 16

9.2 Automatic switch-off ..... 16

9.3 Manual measurement..... 16

9.4 Lock measurement ..... 16

9.5 MAX/MIN/AVG/DIF Read value ..... 17

9.6 Laser display function On/Off ..... 17

9.7 High/low temperature alarm on/off ..... 17

9.8 Function Setting..... 18

9.9 Setting the upper alarm limit..... 18

9.10 Setting the lower alarm limit ..... 18

9.11 Emissivity setting ..... 18

9.12 Setting the temperature unit ..... 19

9.13 Audible alarm setting ..... 19

9.14 Setting the blocking of the measurement ..... 19

9.15 D:S (distance coefficient)..... 19

9.16 Field of vision..... 20

**10 Troubleshooting ..... 21**

**11 Battery operation / power supply ..... 22**  
**12 Maintenance, servicing and disposal ..... 23**  
12.1 Cleaning ..... 23  
12.2 Maintenance and repair..... 23  
12.3 Waste disposal ..... 23  
**13 Battery law ..... 24**  
**14 Appendix ..... 25**  
14.1 Emissivity..... 25

## 1 Technical data

JIT 100	Description of the
D:S ratio	12:1
Measuring range	-32°C~420°C/ -25.6°F~788°F
LCD size	30mm*30mm
LCD display	Colour EBTN
Accuracy	$<0^{\circ}\text{C}: \pm (1.5^{\circ}\text{C}+0.1^{\circ}\text{C}/^{\circ}\text{C});$ $\geq 0^{\circ}\text{C}: \pm 1.5^{\circ}\text{C}$ or $\pm 1.5\%$ of the measured value, whichever is greater $<32^{\circ}\text{F}: \pm (3.0^{\circ}\text{F}+0.1^{\circ}\text{F}/^{\circ}\text{F});$ $\geq 32^{\circ}\text{F}: \pm 3.0^{\circ}\text{F}$ or $\pm 1.5\%$ of the measured value, whichever is greater
Temperature coefficient	$\pm 0.1^{\circ}\text{C}/^{\circ}\text{C}$ or $\pm 0.1\%/^{\circ}\text{C}$ , whichever is greater $(\pm 0.1^{\circ}\text{F}/^{\circ}\text{F}$ or $\pm 0.1\%/^{\circ}\text{F}$ , whichever is greater)
Reproducibility	$0.7^{\circ}\text{C}$ or $0.7\%$ , whichever is greater $(1.5^{\circ}\text{F}$ or $0.7\%$ , whichever is greater)
Emissivity	0.1~1.0 (adjustable, can store 5 sets of presets)
Response time	$\leq 250\text{ms}$ (95% of the measured value)
Spectral response	8 $\mu\text{m}$ ~14 $\mu\text{m}$
Automatic switch-off	15s
Low battery indicator	√
LED alarm for high/low temperature	√
Audible alarm for high/low temperature	√
Hold data	√
Unit conversion (°C/°F)	√
MAX/MIN/AVG/DIFF mode	√
Lock measurement	√
Laser	Single laser, wavelength 630nm~670nm Output power <1mW, class 2 laser

Operating temperature	0°C~50°C (32°F~122°F)
Storage temperature	-20°C~60°C (-4°F~140°F)
Humidity during operation	<RH90% (non-condensing)
Drop test	1m
Battery type	9V battery (6F22)
Battery life	Continuous temperature measurement: ≥ 9 hours for the alkaline battery; ≥4 hours for the carbon battery
Product colour	red and grey
Net weight of the product	204g
Size of the product	161.5 mm x 90 mm x 48 mm

## **2 Declaration of Conformity**

The current EC/EU Declaration of Conformity can be found online at <https://www.kern-sohn.com/shop/de/DOWNLOADS/>

### 3 Overview of the device

#### 3.1 Scope of delivery

- Operating instructions
- Infrared thermometer
- Transport bag
- Battery (9V)

#### 3.2 Components

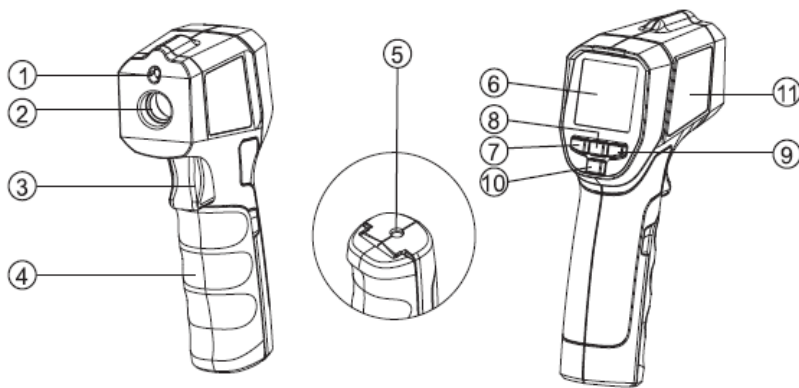

Description of the	Function
1	Laser
2	Infrared sensor
3	Trigger
4	Battery cover
5	Screw hole for stand
6	LCD display
7	MODE button
8	SET button
9	HI/LO button
10	Laser switch button
11	Laser warning sign







## 4 Basic information (general)

### 4.1 General information on warning notices

Warnings are used in these operating instructions to warn you of possible personal injury or damage to property in certain situations.

Signal word	Description of the
<b>DANGER</b>	Failure to observe the instructions will lead directly to serious injury, permanent impairment (e.g. loss of a limb) or death of the user or third parties
<b>WARNING</b>	Failure to observe the instructions may result in serious injury, permanent impairment (e.g. loss of a limb) or death of the user or third parties
<b>CAUTION</b>	Failure to observe the instructions may result in minor injuries or temporary damage to the user or third parties (e.g. minor cuts)
<b>NOTE</b>	Failure to observe the instructions may result in damage to property

#### Symbols in warning notices:

Symbol	Meaning
<b>Warning signs</b>	Warning signs warn you of dangers that may lead to personal injury. The symbol indicates the type of hazard.
	Indicates general hazards or a danger point
	Warning of electrical voltage
	Warning of flammable substances
	Warning of explosive substances
	Warning of laser radiation

Symbol	Meaning
<b>Command sign</b>	Mandatory signs prescribe measures that you must take to avoid personal injury or damage to property. The symbol indicates the necessary actions or objects to prevent damage.
	Indicates a prescribed action

#### 4.2 Intended use

The infrared thermometer JIT 100 (hereinafter referred to as thermometer) is used to determine the surface temperature quickly and accurately by measuring the infrared energy emitted by the target surface. The device is suitable for non-contact measurement of surface temperature. The main fields of application are temperature measurements in industry (e.g. metal processing, mechanical engineering), environmental technology, agriculture, laboratories and maintenance (e.g. wind turbines).

If you have any questions, please contact SAUTER or visit our website [www.sauter.eu](http://www.sauter.eu).

#### 4.3 Improper use

The thermometer is not to be used for medical purposes. The device is not suitable for measuring the temperature of humans or animals, either directly or indirectly.

Do not use the device in flammable or potentially explosive atmospheres or for measurements in liquids or on live parts. This device is not waterproof and cannot be used in environments with high humidity or water mist. Avoid the ingress of liquids, powders or solid foreign bodies such as water and dust into the measuring opening and the housing. Avoid storing the thermometer near high temperatures for long periods of time.

Unauthorised structural changes, additions or conversions to the device are prohibited. Unauthorised modifications may impair the accuracy of the device or even cause irreversible damage to the device.

#### **4.4 Warranty**

Warranty expires with

- Non-compliance with our specifications in the operating instructions
- Use outside the described applications
- Modifying or opening the device
- Mechanical damage and damage caused by media, liquids, natural wear and tear
- Improper set-up or electrical installation
- Improper assembly or electrical installation

## 5 Basic warnings and safety instructions

### 5.1 Observe the notes in the operating instructions



Read the operating instructions carefully before commissioning/using the appliance, even if you already have experience with SAUTER appliances. Always keep the instructions in the immediate vicinity of the appliance.

### 5.2 Staff training

The appliance may only be used by persons who have read and understood the operating instructions, in particular the chapter on safety.

### 5.3 Security

**To avoid eye damage or injury, read the following safety instructions before using the thermometer!**

<b>⚠ WARNING</b>	
	<p><b>Read all safety information and instructions.</b> Failure to observe the safety information and instructions may result in electric shock, fire and/or serious injury.</p> <p><b>Keep all safety information and instructions for future reference.</b></p> <ul style="list-style-type: none"><li>● Check the housing before using the thermometer. Do not use the thermometer if it appears damaged. Look for cracks or missing plastic.</li><li>● The design of the device must not be modified. This can lead to incorrect measurement results, safety defects and the destruction of the device</li><li>● When measuring surfaces with high temperatures, take care not to touch them.</li><li>● Do not operate the appliance in potentially explosive rooms or areas and do not install it there.</li><li>● Do not operate the device in an aggressive atmosphere.</li><li>● Do not immerse the appliance in water. Do not allow any liquids to penetrate the inside of the appliance.</li><li>● The device may only be used in a dry environment and under no circumstances in rain or at a relative humidity above the operating conditions.</li><li>● Protect the device from permanent direct sunlight.</li><li>● Do not expose the appliance to strong vibrations.</li><li>● Do not remove any safety signs, stickers or labels from the appliance. Keep all safety signs, stickers and labels in a legible condition</li><li>● Do not open the device</li></ul>

**⚠ WARNING**



**Risk of injury from laser beam!**

**To avoid eye damage or injury, please read the following safety instructions before using the thermometer:**

- DO NOT LOOK INTO THE LASER BEAM
- OUTPUT <1mW COMPLIANT WITH EN60825-1:2014
- Do not irradiate people or animals directly or indirectly with lasers.
- Do not look directly into the laser or through other optical aids (telescope, microscope, etc.)

**⚠ WARNING**



**Risk of injury from electric shock!**

There is a risk of injury from electric shock when cleaning the appliance with wet cloths.

- Do not use wet cleaning cloths.
- Always use only dry or moistened cloths.

**⚠ WARNING**



**Choking hazard!**

Do not leave the packaging material lying around carelessly. It could become a dangerous toy for children.

- The appliance is not a toy and does not belong in the hands of children.
- This appliance can be dangerous if it is used improperly or not as intended by untrained persons! Observe the personnel qualifications!

**⚠ WARNING**



Improper use of rechargeable or non-rechargeable batteries can cause them to catch fire, explode, emit toxic vapours or release corrosive liquids. The following therefore applies to rechargeable and non-rechargeable batteries:

- Protect from fire and heat.
- Never expose to high pressure or microwaves.
- Do not bring into contact with liquids or chemicals.
- Never bring the electrical contacts of rechargeable batteries and batteries into contact with metal objects or short-circuit them.
- Never modify rechargeable batteries, batteries and chargers.
- Batteries must never be charged.
- Never use or charge a defective, damaged or deformed battery.

### CAUTION

- Keep a sufficient distance from heat sources.
- Do not use the device in environments with high humidity or water mist.

### NOTE

- To prevent damage to the device, do not expose it to extreme temperatures, extreme humidity or moisture.
- Using the thermometer in the vicinity of vapour, dust or environments with large temperature fluctuations can lead to inaccurate temperature measurements.
- Do not use harsh cleaning agents, abrasive cleaners or solvents to clean the appliance.

## **6 Transport and storage**

### **6.1 Hint**

If you store or transport the device improperly, the device may be damaged. Observe the information on transporting and storing the appliance.

### **6.2 Transport**

When transporting the appliance, use the transport case included in the scope of delivery to protect the appliance from external influences.

### **6.3 Storage**

Observe the following storage conditions when the appliance is not in use:

- dry and protected from frost and heat
- protected from dust ingress in the transport bag
- the storage temperature corresponds to the technical data

### **6.4 Packaging/return transport**

Returns are only possible within the limits of the general terms and conditions. Keep all parts of the original packaging for any necessary return transport.

- Only the original packaging is to be used for return transport.
- Disconnect all connected cables and loose/movable parts before despatch.
- Refit any transport locks provided.
- Secure all parts against slipping and damage.

## **7 Unpacking and commissioning**

### **7.1 Unpacking**



In the event of a return, please observe the instructions in the chapter "Packaging/return transport"

---





On receipt of the appliance, you should first check that no damage has occurred during transport, that the outer packaging, the housing, other parts or even the appliance itself have not been damaged. If any damage is evident, please notify SAUTER GmbH immediately.

### **7.2 Initial commissioning**

To ensure the function of the measuring device, insert the supplied battery before use . To ensure measurement accuracy, please place the thermometer in the measuring environment for 30 minutes before use. Check the housing before using the thermometer. Do not use the thermometer if it appears damaged. Look for cracks or missing plastic.



## 8 LCD display

	Lock measured value display	 <p>The diagram shows a rectangular LCD display with the following elements:</p> <ul style="list-style-type: none"> <li>Top row: Lock icon, HI, Buzzer icon, OK, LO, Laser icon.</li> <li>Second row: <math>\epsilon=0.88</math>, HOLD, SCAN, Battery icon, <math>^{\circ}\text{C}/^{\circ}\text{F}</math>.</li> <li>Third row: Large 7-segment display showing 8888.</li> <li>Fourth row: MAX MIN, 88.88.</li> <li>Fifth row: AVG DIF, 88.88.</li> </ul>
	Buzzer display	
HI OK LO	Alarm display for temperature measurement	
	Low battery indicator	
SCAN	Display of the temperature measurement	
HOLD	Temperature hold indicator	
$^{\circ}\text{C}/^{\circ}\text{F}$	Display of the temperature unit	
8888	Main display of the measured temperature	
8888	Auxiliary display of the measured temperature	
$\epsilon=0.88$	Emissivity display	
	Laser display	
MAX MIN AVG DIF	Display of the measuring mode	

## 9 Basic operation

To ensure measurement accuracy, please place the thermometer in the measuring environment for 30 minutes before use

### 9.1 Display the last measured value

If the thermometer is switched off, press the trigger briefly (less than 0.5 s) to switch the thermometer on and the measurement data held before the last switch-off will be displayed. By briefly pressing the MODE button, you can switch between the display of the MAX/MIN/AVG/DIF value.

### 9.2 Automatic switch-off

In HOLD mode, the thermometer switches off automatically if there is no operation for 15 seconds and saves the currently held measured value.

### 9.3 Manual measurement

1. press and hold the trigger after you have focussed on the target. The SCAN symbol flashes and indicates that the temperature of the target object is being measured. The measurement result is updated on the LCD display.

2. release the trigger, the SCAN symbol disappears and the HOLD symbol appears, indicating that the measurement has been stopped and the last measured value is being held.

### 9.4 Lock measurement

#### 9.4.1 Description:

- The lock measurement time (1 minute to 5 hours) can be set in the interface for setting the lock measurement function. For more information, see *Setting the blocking measurement*.
- Once the time has been set, the measurement starts after the lock function has been activated. When the set time is reached, the thermometer switches off automatically and saves the last measured value.
- You can display the measured values by briefly pressing (less than 0.5s) the trigger (NOTE: a long press cancels the measured values). This procedure is suitable for processes that require regular temperature monitoring. If no time measurement is required, simply do not set the time.

#### 9.4.2 Operation:

1. if the lock measurement function is switched on, briefly press the trigger to activate it. The  symbol appears on the thermometer screen and the SCAN symbol flashes. The thermometer now continuously measures the target temperature.

2. press the trigger again, the  and SCAN symbols disappear and the HOLD symbol appears. The thermometer stops the measurement and holds the last measured value.

**NOTE: When measuring, ensure that the measured diameter of the target is twice the spot size (S) of the thermometer and then determine the test distance (D) according to the D:S diagram (see part D:S).**



For example, if you use the UT301A+ to measure the temperature of an object with a diameter of approx. 10 cm (4"), the measuring spot size (S) of the thermometer should be approx. 5 cm (2") for maximum accuracy, and according to the D:S diagram, the measuring distance (D) is approx. 60 cm (24").

### 9.5 MAX/MIN/AVG/DIF Read value

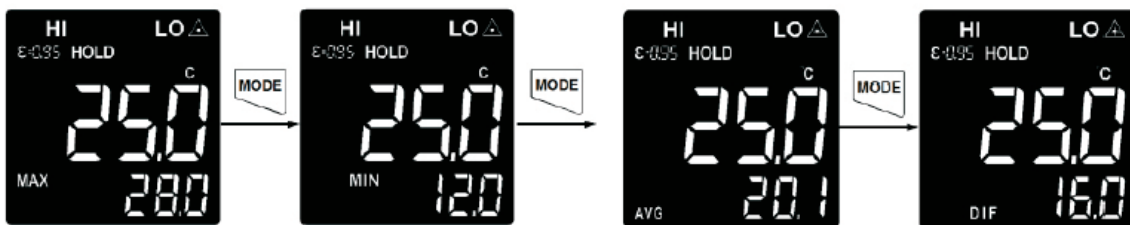
Briefly press the MODE button to switch the measurement mode to "MAX→MIN→AVG→DIF", and the temperature value of the corresponding mode will be displayed in the auxiliary display area (as shown below).



### 9.6 Laser display function On/Off

Briefly press the  button to switch the laser display function on or off. When it is switched on, the laser display  is shown on the LCD display and the laser accurately indicates the position you are measuring during the temperature measurement.

**NOTE: Please observe the precautionary measures when switching on the laser to prevent damage to the eyes of people and animals.**

### 9.7 High/low temperature alarm on/off

Briefly press the HI/LO button to switch the alarm function for the upper and lower limit value on and off in sequence.

If the HI limit alarm function is switched on and the measured temperature value is above the set upper alarm limit, the red LED and the HI display flash. If the audible alarm function is switched on, the buzzer sounds.

If the LO limit alarm function is switched on and the measured temperature value is below the set lower alarm limit, the blue LED and the LO indicator flash. If the audible alarm function is switched on, the buzzer sounds.

When the HI/LO limit alarm function is switched on and the measured temperature value is within the upper and lower alarm limit range, the green LED lights up and the OK indicator is displayed, which means that the measured temperature is normal.

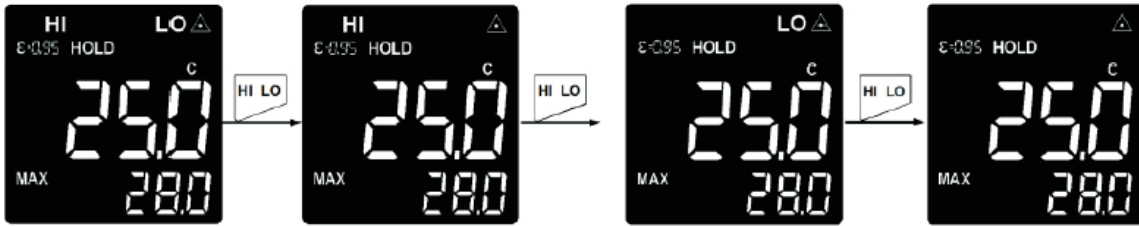

## 9.8 Function Setting

In the HOLD interface, briefly press the SET button to enter the settings for upper alarm limit → lower alarm limit → emissivity → temperature unit → audible alarm → measurement lock, etc. In these setting interfaces, pull the trigger or do not press for 10s to return to the HOLD interface.

### 9.9 Setting the upper alarm limit

In the HOLD interface, briefly press the SET button once to call up the interface for setting the upper alarm limit value. Briefly press the button to quickly select the preset value for the upper alarm limit (P1-P5). If there is no desired value among the preset values, select any value that comes closest to the upper alarm limit value and set it by pressing the or button. A short press adds or subtracts 1 each time, a long press adds or subtracts 10 per second.

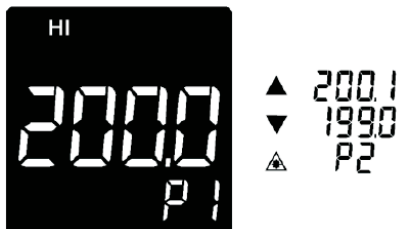

### 9.10 Setting the lower alarm limit

In the HOLD interface, short press the SET button twice to enter the low alarm limit setting interface and set the low alarm limit value by pressing the or button. Add or subtract 1 each time by short pressing and add or subtract 10 per second by long pressing.

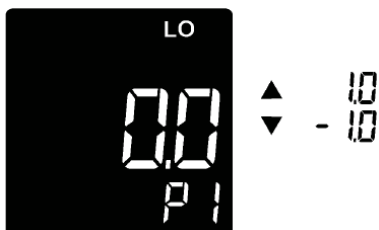

### 9.11 Emissivity setting

Briefly press the SET button in the HOLD interface until the emissivity setting is displayed. Briefly press the button to quickly select the preset emissivity value (P1-

P5). If there is no desired value among the preset values, select any value that comes closest to the emissivity and set it by pressing the ▼ or ▲ button. Add or subtract 0.01 each time by pressing briefly and add or subtract 0.1 per second by pressing and holding.

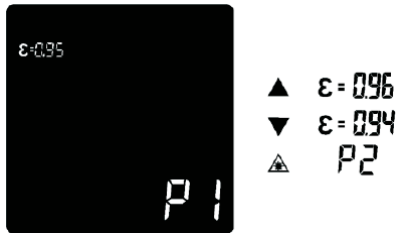

### 9.12 Setting the temperature unit

In the HOLD interface, briefly press the SET button until the temperature unit is displayed and switch between °C and °F by pressing the ▼ or ▲ button.

### 9.13 Audible alarm setting

In the HOLD interface, briefly press the SET button until the setting for the audible alarm is displayed and switch the audible alarm on/off by pressing the ▼ or ▲ button.

### 9.14 Setting the blocking of the measurement

Briefly press the SET button in the HOLD interface until the setting for the lock measurement is displayed and switch the lock measurement on/off by pressing the ▼ or ▲ buttons. If the locking measurement is switched on, press the ▲ button to set the time "00:00" for the locking measurement. At this point, the selected time position flashes and the time value can be set by pressing the ▼ or ▲ button. Set the time measurement to "00:00" to switch off the time measurement function.



### 9.15 D:S (distance coefficient)

The greater the distance (D) between the object to be measured and the thermometer, the larger the measuring spot (S) on the measured surface. The relationship between the distance and the spot size is as shown below.

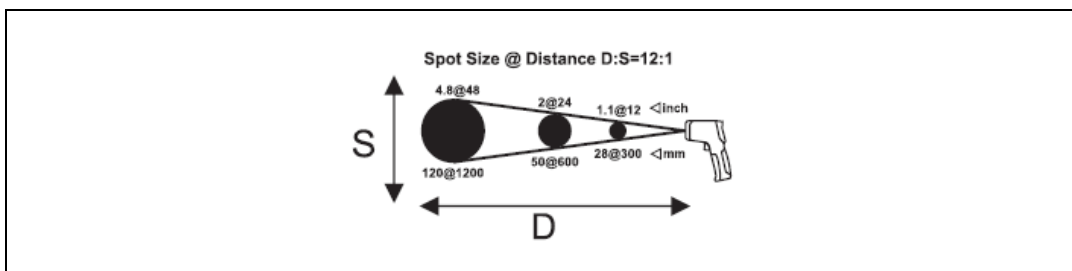

**9.16 Field of vision**

Make sure that the measured target is larger than the measuring spot. The smaller the target, the smaller the measuring distance should be (see D:S for the measuring spot size at different distances). To achieve an optimum measurement result, it is recommended that the target is 2 times larger than the measuring spot.

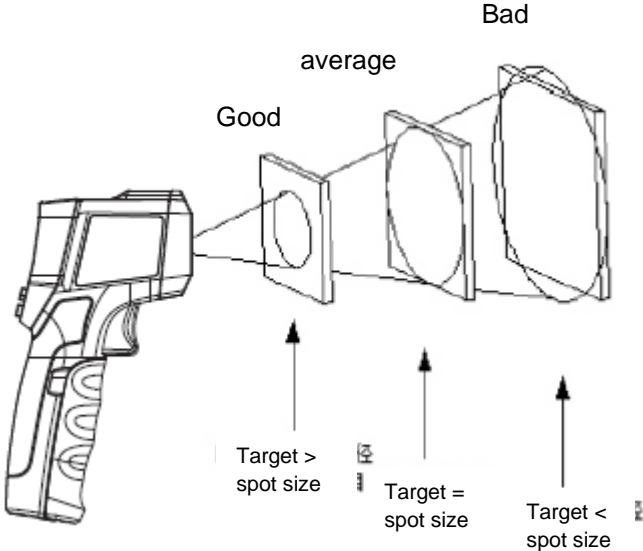

## 10 Troubleshooting

Symptom	Problem	Action
<b>OL</b> appears during the measurement	The measured value is greater than the maximum range	End measurement
<b>OL</b> appears during the measurement	The measured value is below the minimum range	End measurement
<b>Err</b> appears on boot	Exceeding the minimum or maximum operating ambient temperature	Place the thermometer in an environment of 0°C~50°C (32°F~122°F) and it can be used again after 30 minutes.
Battery indicator flashes	Weak battery	Replace the battery
Laser does not work / weak laser	Weak battery	Replace the battery
The measurement is inaccurate	The emissivity does not match, the measured distance is too large, the measured target diameter is smaller than 20 mm, etc.	Please refer to the instructions for details of the field of vision, D:S etc.

## 11 Battery operation / power supply

### ⚠ WARNING



**Risk of fire and explosion due to incorrect charging or defective battery**



**Fire or explosion can lead to serious injuries**

- ⇒ Be sure to observe the notes on rechargeable batteries and batteries in the Safety chapter.
- ⇒ Observe the national and international transport regulations for devices with a permanently installed lithium-ion battery.
- ⇒ Do not replace defective batteries yourself! Contact SAUTER or a specialist dealer directly.

This device is equipped with a 9V battery (6F22).

- If the battery symbol flashes on the LCD display, please replace the battery immediately to avoid inaccurate measurements.

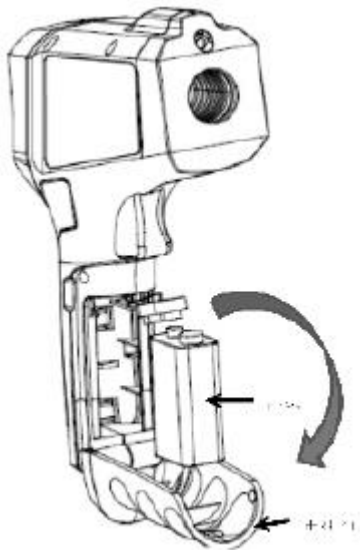

#### **Replacing the battery**

Insert the supplied 9V battery (6F22) or replace it as follows:

1. open the battery cover.
2. insert the battery and pay attention to the polarity.
3. close the battery compartment cover.



## 12 Maintenance, servicing and disposal



Disconnect the appliance from the power supply before carrying out any maintenance, cleaning or repair work.

### 12.1 Cleaning

Clean the device with a damp, soft, lint-free cloth. Ensure that no moisture penetrates the housing. Do not use sprays, solvents, alcohol-based cleaners or abrasive cleaners, only clear water to moisten the cloth. Use clean compressed air to blow away falling particles. Use a damp cotton bud to carefully wipe the lens surface.

Do not rinse the thermometer or immerse it in water.

### 12.2 Maintenance and repair

Do not make any changes to the device and do not install any replacement parts. Contact the manufacturer for repairs or device inspections to ensure the safety and accuracy of the thermometer.

### 12.3 Waste disposal



Old appliances and accessories should not be disposed of with household waste.

The operator must dispose of the packaging and appliance in accordance with the applicable national or regional legislation at the place of use.

The device consists of various components and materials, such as

- Electronic components (circuit boards, electrical cables)
- Plastic (housing)
- Metal

Improper disposal of the appliance can have harmful effects on people and the environment.

Proper and environmentally friendly disposal can prevent harmful effects and recover raw materials.

#### Disposal of rechargeable batteries and batteries:

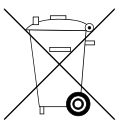

Rechargeable batteries and batteries do not belong in household waste.

The disposal of rechargeable batteries and batteries must be carried out by the operator in accordance with the applicable national or regional law of the place of use.

## 13 Battery law

Note in accordance with the Battery Act - BattG:

### INFORMATION



- The following information is valid for Germany.

In connection with the sale of batteries and rechargeable batteries, we are obliged as a dealer under the Battery Act to inform end users of the following:

- End users are legally obliged to return used batteries and rechargeable batteries.
- After use, batteries and rechargeable batteries can be returned free of charge to municipal collection centres or retailers. The batteries/rechargeable batteries must have reached the end of their normal service life, otherwise precautions must be taken against short circuits.
- The return option is limited to batteries and rechargeable batteries of the type that we carry or have carried in our range and to the quantity that end users usually dispose of.
- A crossed-out wheelie bin means that you must not dispose of batteries or rechargeable batteries in household waste. Old batteries or rechargeable batteries may contain harmful substances that can damage people and the environment if not disposed of correctly.

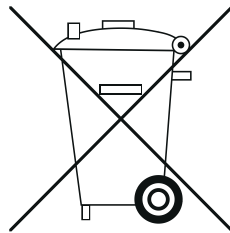

- Batteries containing harmful substances are labelled with a symbol consisting of a crossed-out dustbin and the chemical symbol (Cd = cadmium, Hg = mercury, or Pb = lead) of the heavy metal that is decisive for the classification as containing harmful substances.

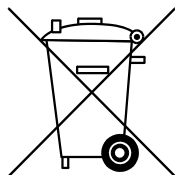

**Cd**

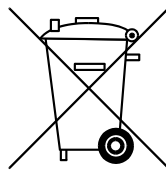

**Hg**

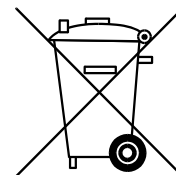

**Pb**

## 14 Appendix

### 14.1 Emissivity

Emissivity is a symbol for the energy radiation of a material. The emissivity of most organic materials and coated or oxidised surfaces is around 0.95. To measure the temperature of a bare metal surface, cover the surface to be tested with masking tape or matt black paint with a high emissivity (if possible), wait a certain amount of time and measure the temperature of the masking tape or black paint when it reaches the same temperature on the surface of the underlying object. The following table gives an overview of the emissivity values of the various materials, but is neither binding nor complete.

Measured surfaces	Emissivity
<b>Metal</b>	
Aluminium Oxidation	0.2-0.4
A3003 Alloy Oxidation Rough	0.3 0.1-0.3
brass Polishing Oxidation	0.3 0.5
Copper Oxidation Electrical terminal strip	0.4-0.8 0.6
Hastelloy Alloy	0.3-0.8
Inconel Oxidation Sandblasting Electropolishing	0.7-0.95 0.3-0.6 0.15
Iron Oxidation Rusting	0.5-0.9 0.5-0.7
Iron (cast iron) Oxidation Non-oxidation Pouring	0.6-0.95 0.2 0.2-0.3
Iron (forging) Passivation	0.9
Lead Rough Oxidation	0.4 0.2-0.6
Molybdenum Oxidation	0.2-0.6
Nickel Oxidation	0.2-0.5
Platinum Black	0.9

Steel	
Cold rolling	0.7-0.9
Reaming steel plates	0.4-0.6
Burnishing steel plates	0.1
Zinc	
Oxidation	0.1
Non-metal	
Asbestos	0.95
Asphalt	0.95
Basalt	0.7
Carbon	
Non-oxidation	0.8-0.9
Graphite	0.7-0.8
Silicon carbide	0.9
Ceramics	0.95
Clay	0.95
Concrete	0.95
Fabric	0.9
Glass	
Convex glass	0.76-0.8
Smooth glass	0.92-0.94
Lead-boron glass	0.78-0.82
Plates	0.96
Plaster	0.8-0.95
Ice	0.98
Limestone	0.98
Paper	0.95
Plastics	0.95
Water	0.93
Floor	0.9-0.98
Wood	0.9-0.95